

FNC Programmable MT Analog Output

Current / voltage output



FNC 50B MT Programmable Analog Output Ø50 Flange



Features

- Programmable measuring range
- Industry 50 mm end hollow shaft version
- Robust mechanical and electrical construction
- Protection up to IP67
- 0-10V voltage / 4-20mA current output

Output Options :

- Programmable;
- 0-10VDC Voltage
 - 0-5VDC Voltage
 - 4-20mA current

Technical data - electrical ratings

Voltage supply	10-30VDC
Protection:	Output short circuit protection. Reverse polarity protection
Consumption w/o load	≤60 mA (24 VDC)
Output signals	0-10VDC Voltage output 0-5VDC Voltage output 4-20mA current output
Measuring range	up to 65536 revolution
Interference immunity	DIN EN 61000-6-2
Emitted interference	DIN EN 61000-6-4
Approval	CE

Technical data - mechanical design

Dimensions (flange)	ø50 mm
Shaft loading	≤140 N axial ≤240 N radial
Protection DIN EN 60529	IP54, IP65
Operating speed	≤10000 rpm
Starting torque	≤0.025 Nm (IP 65)
Materials	Housing: Aluminium Flange: Aluminium Shaft : Stainless steel
Shaft/Hollow shaft diameter:	6, 8, 10, 12 mm (other diameters on request)
Bearings lifetime:	2x10 ⁹ rev. at 100% of full rated shaft load (minimum)
Operating temperature	-20...+85 °C
Storage temperature	-30 °C up to +90 °C
Weight approx.	250 g

Pulse Diagram

Example: 128 revolution current output.

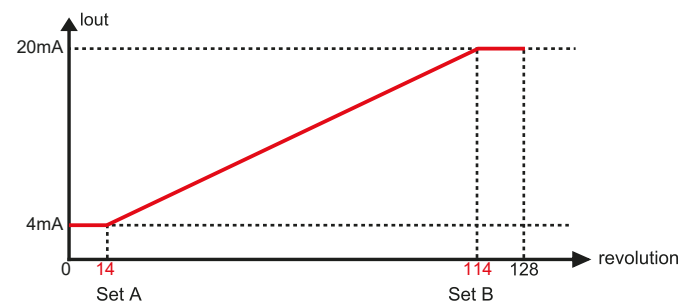

FNC Programmable MT Analog Output

Mechanical Dimensions
Cable/Connector Wiring, Part Number



Ø50 Flange FNC 50B MT Programmable Analog Output

Mechanical Dimensions

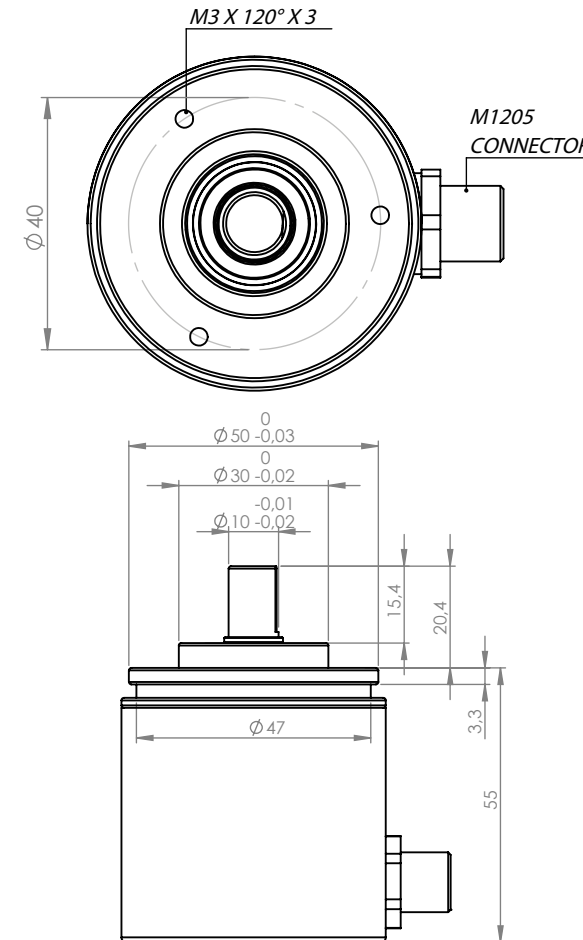

Cable Wiring

Function	Color	Renk	Explanation
+VB	Brown	Kahve	Supply voltage
GND	White	Beyaz	Ground
V	Green	Yeşil	Voltage output
A	Red	Kırmızı	Current output

Connector Wiring

Connector Type	Analog Output	+VDC	GND	SET1	SET2
CRM1205	1	2	3	4	5

Teach Procedure

- Teach Procedure 1:
Press A and B button for 10 sec.
Leds will flash.
At start point press A button
- Teach Procedure 2:
Turn shaft CW to final point.
Press B button at final point.
Teach procedure is done.

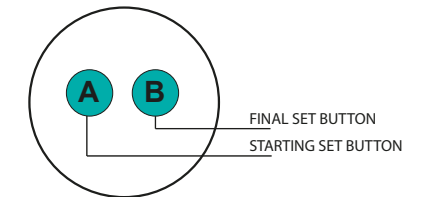

For fabrication settings press A and B button for 30 sec.

Encoder Part Number

